

# 382-387LT SUMMIT® 1.28

**MANSFIELD®**

Elongated Front, Vitreous China, Two-Piece Toilet

## FEATURES

- High performance MagnaFlush™ flushing technology
- SmartFasten™ 3-bolt tank-to-bowl connection
- 1.28 gpf / 4.8 lpf high efficiency water consumption
- Elongated front bowl
- PuraClean® easy-to-clean glaze
- Fluidmaster® pilot operated anti-siphon fill valve
- 3" Rigid Flapper flush valve – requires less force to flush, is more consistent and uses a simple universal repair part/seal
- Lined tank for reduced condensation
- Model 57 chrome-plated, metal trip lever
- 12" rough-in
- 2" glazed trapway
- The Mansfield® limited lifetime warranty on china;  
Five-year limited warranty on tank trim
- Available in White, Biscuit and Bone





**MODEL 382-387LT**

Toilet seat not included



ELONGATED

## COMPONENTS

MODEL #	DESCRIPTION	CODES/STANDARDS
<b>382-387LT</b>	Elongated front, two-piece toilet. Less toilet seat and supply. Specify color.	  
<b>382</b>	Elongated front toilet bowl only. Less toilet seat and supply. Specify color.	
<b>387LT</b>	Tank and cover only, with left hand, front-mount, chrome-plated, metal trip lever. Tank liner. Less supply. Specify color.	
TANK TRIM & REPLACEMENT PARTS		
<b>57</b>	Trip lever - chrome-plated, metal trip lever, left hand	
<b>2036-1212</b>	Summit® 1.28 rigid flapper flush valve	
<b>400A</b>	Fluidmaster® anti-siphon pilot fill valve	
<b>2206</b>	Anti-siphon pilot fill valve (compatible replacement)	
<b>630-0030</b>	Replacement flush valve seal	
<b>386-LID</b>	Tank lid	





# 382-387LT SUMMIT® 1.28



Elongated Front, Vitreous China, Two-Piece Toilet

## SPECIFICATIONS

MODEL #	DESCRIPTION	CODES/STANDARDS
382-387LT	Elongated front, (1.28 gpf/4.8 lpf) two-piece toilet	  

MATERIAL	Vitreous China
WATER PRESSURE RANGE	20 to 80 PSI
FLUSH SYSTEM	MagnaFlush™ flushing technology
WATER USAGE	1.28 gpf / 4.8 lpf
WATER SURFACE AREA	9' X 10'
ROUGH-IN	12'
MAP RATING	1,000 grams

TRAP DIAMETER	2'
TRAP SEAL	2-1/4'
SHIPPING WEIGHT	Model 382 - 50 lbs. (22.6 kg) Model 387LT - 36 lbs. (16.3 kg)
WARRANTY	Vitreous China - Limited Lifetime Tank Trim - Limited Five Year

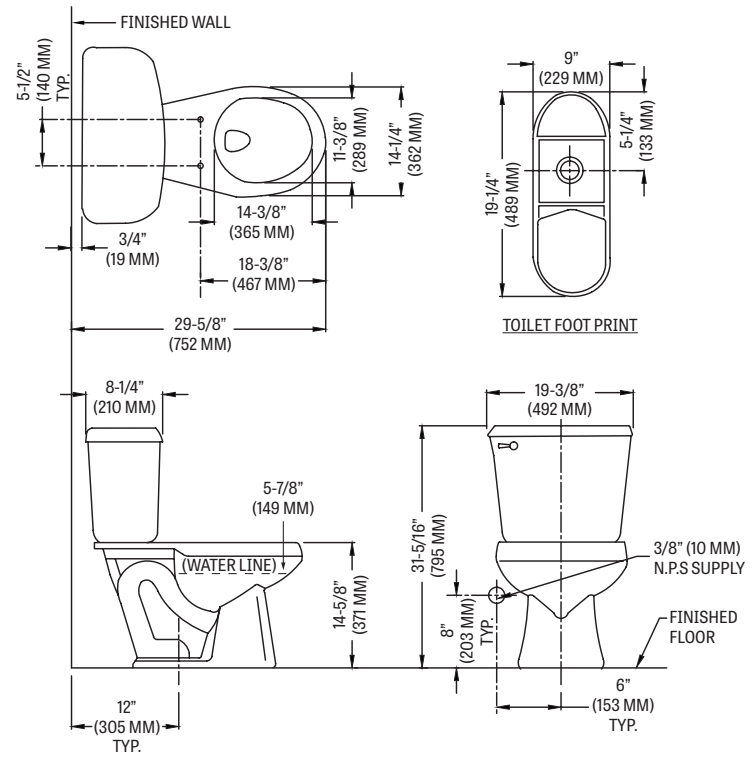
TANK OPTIONS		TECHNICAL INFORMATION
387RH	Variation of model 387, with right hand trip lever.	<p><b>Note:</b> these dimensions are nominal and subject to change without notice.</p> 
387LT	Variation of model 387, with tank liner.	

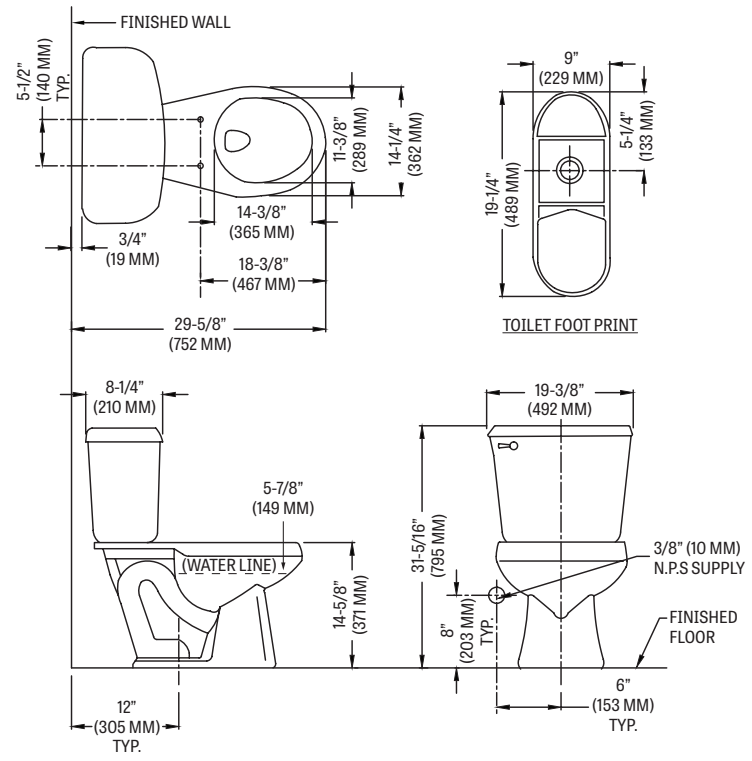

Fixture performance and specifications meet or exceed ASME A112.19.2/CSA B45.1 standards, and other state and local codes.

